

3

CHANNEL SYSTEMS

INSTALLATION MANUAL

Before Installing:

1. Read the INSTRUCTIONS!
2. USE A DIGITAL OR ANALOG VOLT/OHM METER
3. BEFORE MOUNTING THE PRODUCT CHECK THE POSSIBLE LOCATIONS FOR THE SIREN, LED, AND MODULE BEFORE YOU PERMANENTLY INSTALL THEM.
4. PROTECT THE VEHICLE BY USING FENDER COVERS.
5. ROLL DOWN THE DRIVER'S WINDOW BEFORE STARTING THE INSTALLATION.
6. ALWAYS LOOK BEFORE DRILLING. MAKE SURE YOU WILL NOT CAUSE DAMAGE TO VEHICLE HOSES, ELECTRICAL LOOMS OR PHYSICAL DAMAGE TO VEHICLE.
7. PROGRAM THE DIP SWITCH ON THE MODULE FIRST(SEE DIP SWITCH

INFORMATION.)

8. REMOVE DOME LIGHT FUSE TO PREVENT BATTERY DRAIN.

Timing Information

Automatic reset time: 45 seconds,

Panic output reset time: 45 seconds,

Arming time (when all inputs are monitored): 10 seconds-active arm, passive 30 +10 seconds (40 total)

Door Lock output time: .75 seconds or 3 seconds (programmable via dip switch #1)

2nd Channel output: Pressing button 2 for 3 seconds provides output for as long as button is pressed.

3rd Channel output: Pressing both buttons 1 & 2 (3rd button on a 3-button remote) simultaneously provides continuous output on 3rd channel as long as both buttons are pressed.

Armed output: Orange wire will pro-

duce a grounded output when system is armed.

Flashing Parking Light Output:

Armed: 1 second pulsed, *Disarmed:* 2-one second pulses-, then output will latch on for 30 seconds, or until ignition is turned on, or system rearms. *System triggered:* 1 second pulse on, 1 second off, repeated for 45 seconds.

Dome Light Output: Output is identical to Flashing Parking Light Output.

Super Selective Receiver Board:

The new receiver design allows for a much narrower band width reception. It rejects RF interference that causes inconsistent range in similar type products and improves the range of transmission between remote and receiver. Average minimum range is 100' although it is common to get between 150'-300'. Our extended range model with windshield mounted receiver allows for up to 500' of range.

Input Zone Out Feature:

If a door input, shock or sensor input remains on for 4 consecutive cycles (45 seconds) that input will be ignored. If the input returns to a non-triggered state for 30 seconds it will be monitored by the system again.

PROGRAMMING FEATURES

3 CHANNEL SOFTWARE UPDATE

All 3 channel platforms have been updated with new programmable features!

Features that can be programmed are the following:

1. Parking lights can be programmed to not stay on after disarm (car locator function).
2. Double unlock pulses can be added.
3. The 3rd channel can be programmed to give a pulsing output when alarm is triggered to be connected to the car horn.
4. 2nd channel Auto disarm feature, when

3 Channel Programmable Features:

Feature #	Button One=ON	Feature #	Button Two=OFF
(1)	Car Locator feature ON (parking lights stay on 30 sec. after disarm).	(1)	Car Locator feature OFF
(2)	Single unlock pulse	(2)	Double unlock pulse
(3)	Red/White wire is 3rd. Channel output	(3)	Red/White wire is (-) horn output
(4)	Channel# 2 normal operation	(4)	Auto disarm when Ch.# 2 used

Default features are all ON. To change all features to default position enter program mode as above and press both buttons 1&2 together until siren chirps.

the 2nd channel is used for opening the trunk or hatch, the alarm (if armed) will automatically disarm.

To program these specific features follow the procedure below:

1. Turn ignition key to the ON position
2. Press the valet switch 5 times (*siren will give long chirp*).
3. Then select the program that you wish to change and press the valet switch the same number of times. The siren will chirp each time you press the switch.

4. Press button one or two on the transmitter to change to the desired program to the feature.

Example: *Programming the 3rd channel to horn output.*

1. Ignition Key On,
2. Press Valet switch 5 times
3. Siren will give long chirp,
4. Next, press Valet switch 3 times, siren will chirp after each time you press the switch
5. Press button #2 on transmitter
6. Turn ignition key off. The red/white wire on the main harness now is programmed to be

Summary of Inputs and outputs:

Inputs:

- | Sensor port-4 wire (w/warn away)
- | Sensor port -3 wire
- Negative door trigger
- | Negative hood/trunk trigger
- | Positive door trigger

**Module with door lock relays on board*

Outputs

- Siren output: 3 amp Max - positive
- Flashing lights: relayed - 15 amp Max
- Starter Interrupt: relayed:40 amp (N.C.)
- Dome Light: relayed- 15 amp Max
- Door lock/unlock : 500 ma -negative
- Door lock/unlock: relayed* 15 amp max
- 2 nd Channel: 500 ma- negative
- 3rd Channel: 500 ma - negative
- Armed Output: 250 ma - negative

Dip Switch Programmable Features:

- | | | |
|---|-----------------|------------------|
| Switch #1= Lock/Unlock Pulse Time: | ON= .75 seconds | OFF= 3 seconds |
| Switch #2= Ignition Triggered Door Locks: | ON= Feature On | OFF= Feature OFF |
| Switch #3= Passive Door Locks: | ON= Feature On | OFF= Feature OFF |
| Switch #4= Passive or Active Arming: | ON= Passive Arm | OFF= Active Arm |

a horn output when the alarm is triggered or panicked.

Chirp Delete: If you would like to turn off the arm/disarm chirps:

1. System disarmed,
2. Turn ignition to the on position,
3. Press and hold Button #2 until you hear a double chirp. Arm/Disarm chirps will remain turned off until above procedure is repeated. When Arm/Disarm chirps are turned back on you will hear 2 double chirps.

Temporary Remote Trigger Bypass: If you wish to have the system ignore all inputs (door, trunk and shock or auxiliary sensor), but wish to have the starter disable feature engaged:

1. Press Button #1, you will hear a normal arming chirp, (as long as arming chirps are on).
2. Within 5 seconds press Button #2, you will hear a second short chirp, confirming that all inputs will not be monitored.

Once you disarm and rearm, the hood and doors will be monitored normally.

Temporary Remote Sensor Bypass: If you wish to have the system ignore the shock and auxiliary sensor inputs (Customer is leaving pet or children in vehicle but wishes to monitor doors and hood or trunk)

1. Press Button #1, you will hear a normal arming chirp, (as long as arming chirps are on).
2. Within 5 seconds press Button #1 & 2 simultaneously. You will hear a second

short chirp, confirming that the shock sensor and auxiliary sensor input will not be monitored. Once you disarm and rearm, the hood and doors will be monitored normally.

Using the temporary remote sensor and trigger bypass to diagnose falsing problems will allow you to easily find the defective input. (Have the customer turn one or the other off, and see if falsing still occurs).

NOTE: You may not turn off both sensor or trigger inputs at the same time.

Silent Arm/Disarm: If you wish to arm or disarm you alarm, but do not want the siren to chirp:

1. Press Button #2 momentarily. This will temporarily delete the arm or disarm chirps. Chirp can only be heard if standing right next to the vehicle. Chirps will be muted for one complete cycle (arm/disarm).

Using Valet/Override Switch

Valet Mode: If the system is programmed to passively arm (dip switch #4 on), and you wish to keep system from arming but wish to retain keyless entry features:

1. Disarm the system.
2. Turn ignition to on.
3. Press and hold valet/override switch for approximately 3 seconds.
4. LED will turn on solid, Siren will chirp once.

To exit Valet mode: Repeat the procedure, LED will turn off momentarily and

the siren will chirp twice.

Emergency Override: If you lose your remote or it becomes inoperable, and system is armed:

1. Open door and enter vehicle (Siren will sound, lights will flash).
2. Turn ignition key to on.
3. Press the override switch.
4. System will disarm, and automatically enter Valet mode, regardless of whether system is programmed to passively or actively arm.

Code Learning Mode: If you wish to “teach” the system different remote controls:

1. Make sure system is disarmed or in valet mode,
2. Turn ignition switch on 3 times within 5 seconds and leave in the on position (ON, OFF, ON , OFF, and ON), you will hear one chirp from the siren, LED will flash one time,
3. Within 5 seconds press and hold valet/override switch for approximately 5 seconds, you will hear a series of chirps and LED will turn on solid,
4. Release the valet switch, and within 5 seconds you must press button 1 of all transmitters that you desire to operate the system. You will hear a chirp after the system has learned each remote control. The system will hold 3 different codes in memory.

NOTE: Once you enter the code learning mode, the system will throw out any previous programmed remotes. If you are

programming two remotes with the same code, the system will acknowledge only the first remote. Even though both remotes will operate the system.

INSTALLATION INSTRUCTIONS:

1. Mount the module and program dip switch functions (see page 3):

Look for a suitable mounting location under the dash or inside the vehicle that will be difficult for a potential thief to locate the module, but allow for a convenient installation position.

Keep the antenna wire away from wire looms, computer modules and metallic objects for better range. Wire tie or screw the module securely.

2. Mount the Siren:

Locate a suitable place under the hood, away from hot and moving engine parts such as manifolds, turbo chargers, fan belts, etc. Secure siren by screwing bracket to a solid location under the hood. Make sure that there is no outside access to both siren and wire from underneath the vehicle or through the grill. Point the siren down so that water may not accumulate inside the siren bell. Ground the black wire of the siren to a solid ground; preferably, use a star washer and ring terminal.

When running wires inside the vehicle to the module location, use either tape or split loom tubing to cover and route the red wire to the firewall. Always use either existing grommets or if a new hole is needed to be drilled protect the wire from chaffing by installing a proper size grommet.

3. Mount the shock sensor:

Mount the dual stage shock sensor using a wire tie to the steering column, or thick wire harness, or even a dash brace. Plug the harness into the shock sensor, then plug the other end into the 4 pin white connector on the module. Make sure that the adjustment screw is accessible for later testing and adjustment. Do Not mount sensor under the hood!

4. Install the Status Indicator (LED):

Locate a suitable place for the status indicator (LED), drill the appropriate size hole (7/16"). Make sure there is enough depth for the LED to fit all the way in, and can be easily seen from outside the vehicle. Carefully run the LED and 2 pin red connector and wire harness to the module and plug into the matching red two pin connector on the module. Push the LED into the hole, it should fit snugly.

5. Install the Valet/Override Switch:

Mount the valet/override switch in a hid-

den location, but that can still be found by the customer for programming and emergency override situations. Run the 2 pin blue connector and wire harness to the module and plug into the matching blue 2 pin connector on the module.

6. Connect Starter Disable Relay:

Using a volt/ohm meter locate the starter wire (normally a heavier gauge wire) off of the ignition switch. The meter will read 12V+ only during cranking. When the starter wire has been located, cut the wire, the vehicle should not be able to start now. Cut the brown starter disable wire (with the two female connectors). Connect one side to the vehicle's starter wire, then plug to either .25 male spade lugs on the module. There is no polarity. Connect the other brown wire to the other starter wire off of the ignition switch. Plug the brown wire to the other .25 male spade lug on the module. The car should now start.

7. Connect the Illuminated Entry Output: Black/White wires on main harness

If the vehicle has a negative door switch, connect one of the two black/white wires from the main harness to ground. Connect the second black/white wire to the green wire, also from the main harness (negative door input). If the vehicle

has a positive door switch, connect one of the black/white wires to a constant 12V+ source and the other black/white wire to the violet wire also from the main harness (positive door input).

8. Connect Optional Armed Output: Orange wire on the main harness

This wire provides a 250 ma ground output when the alarm is armed. It can be used to control optional modules. (i.e. window control modules, or used with another relay to interrupt another circuit- such as fuel pump, ignition).

9. Connect 2nd channel output: Gray wire on main harness

This output is 500ma, and drives a relay to open the electric trunk or hatch release. (See diagram section).

NOTE: This output will work with the ignition on or off. Press Button # 2 and hold for 3 seconds. You will receive output on the gray wire as long as you hold Button # 2.

10. Connect Negative door input: Green wire on main harness

Connect the green wire from the module to the wire that shows ground when all of the doors are opened. Verify with a volt/ohm meter. Make sure that all doors when opened separately make the target wire provide a ground output.

11. Connect Hood/ Trunk switch input: Blue wire on main harness

Connect the blue wire to either or both hood and trunk switches. They must provide a ground output when the trunk or hood are opened.

12. Connect Positive Door input: Violet wire on main harness

Connect the violet wire from the module to the wire that shows 12V+ when all of the doors are opened. Verify with volt/ohm meter. Make sure that all doors when opened separately make the target wire provide a 12V+ output.

13. Connect Siren Output: Brown wire on main harness

Connect the brown wire on the main harness to the red wire from the siren.

14. Connect the Flashing Parking Light Output: White wire main harness.

Using a volt/ohm meter, locate the wire (usually on the head light switch) that shows 12V+ when only the parking lights are switched on. European vehicles may require an additional relay if they have separate wires that switch on the left and right side parking lights.

This relayed output has a maximum of 15 amps. Do not hook to head lights. (See diagram section).

15. Connect 12V+ Power Input: Red wire on main harness

Connect the red fused wire on the main harness to a constant 12V+ source. This source wire should be at least 20 amp supply. There usually is a main constant power wire on the ignition switch. Use volt/ohm meter to verify.

16. Connect the 12V+ ignition input: Yellow wire on main harness

Connect the yellow wire on the main harness to a main ignition wire. This can be also found in the main ignition switch wire harness. Your volt/ohm meter will read 12V+ when key is turned on. Make sure that this ignition wire has 12V+ on even during the starting process of the vehicle. It is important that the voltage does not drop when the car is starting. Some vehicles have ignition wires that remain or slowly drop to 0 volts. Verify that when the ignition is shut off that the voltage drops to 0 Volts immediately. If the yellow wire has voltage on it after the key is turned off, it will keep the alarm from arming via the remote.

17. Connect Ground Input: Black wire on main harness

Locate a good solid chassis ground and connect to the black wire on main harness. Verify the ground with your volt/ohm meter.

18. Connect optional third channel output: White/Red wire on main harness

Connect the white/red wire on main harness to an optional relay or accessory module to control via the 3rd channel. Ideal for window roll up or remote start. To use this feature press both buttons 1&2 on 2 button remote control, or Button # 3 on 3 button remote. **NOTE:** This output will work with the ignition on or off and will provide output on the white/red wire as long as you hold proper transmitter buttons.

19. Connect the door lock wires: Blue and Green on 5 pin harness.

For Module without on board door lock/unlock relays:

The blue wire provides a 500 ma negative pulsed output for unlock, this output is designed to drive a relay (See diagram section).

The green wire provides a 500 ma negative pulsed output for lock, this output is designed to drive a relay (See diagram section).

The Violet, Brown and White wires do not need to be connected on the 3 channel module without on board relays for door locks.

For Module with on board door lock/unlock relays:

Connect the violet wire to the proper polarity (negative or positive).

Connect the Brown wire to the door unlock switch wire (see diagram section).
Connect the Blue wire to the door unlock motor wire (See diagram section).
Connect the Green wire to the door lock motor wire (See diagram section).
Connect the White wire to the door lock switch wire (See diagram section).

20. Plug in main harness and 5 pin door lock harness to module.

21. Test features and functions, adjust shock sensor.

Arm and disarm system, check that the siren chirps and parking lights are functioning normally. Make sure that the programmed features (via dip switch) are performing correctly, ie.: ignition locks, passive arming, passive locks, etc.
Test the doors and hood or trunk inputs (make sure that you check that all doors trigger the system not just the drivers door). Do this with the Silent Test Mode.
Adjust the shock sensor (clockwise for more sensitive, counter clockwise for less sensitive), make sure that it is not too sensitive.

Arm the system and try starting the vehicle, it should not start.

Arm the system and disarm it with the ignition and override switch.

If programmed to passively arm make sure that the system properly arms.

Check for range with the remotes. See

that they arm and disarm all the way around the vehicle; adjust the module antenna location if necessary.
Using the remote and valet switch, check for the user features: chirp mute, service mode, valet mode, temporary trigger and sensor bypass, and chirp delete.
Tie up wire harness, and replace any under dash panels.
Deliver the vehicle to customer.
Make sure the customer has physical knowledge of the location of the valet/override switch.

3 CHANNEL WITHOUT ON BOARD DOOR LOCK RELAYS (2800)

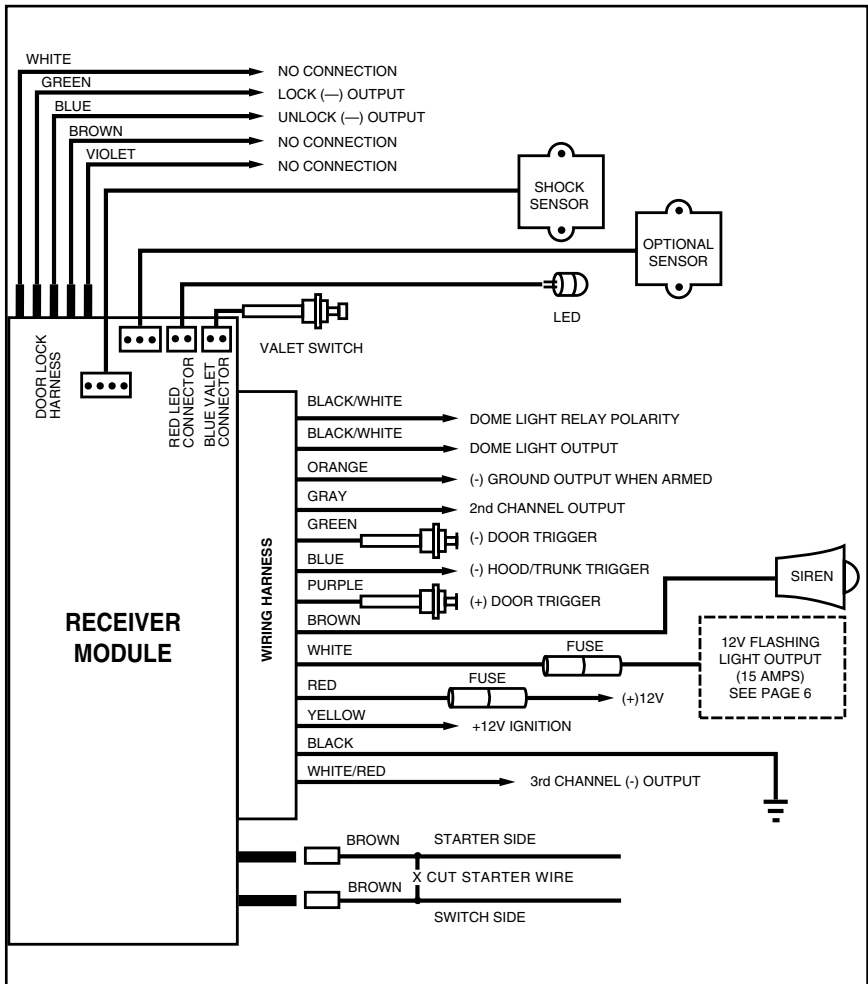

3 CHANNEL WITHOUT ON BOARD DOOR LOCK RELAYS DOOR LOCK DIAGRAMS (2800)

POSITIVE PULSE DOOR LOCK SYSTEM

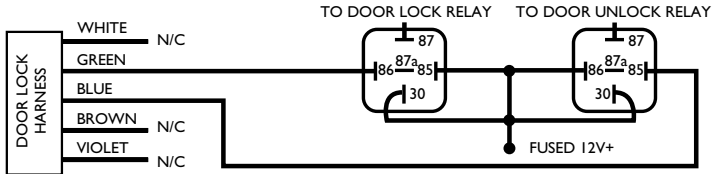

REVERSE POLARITY ADD-ON ACTUATOR

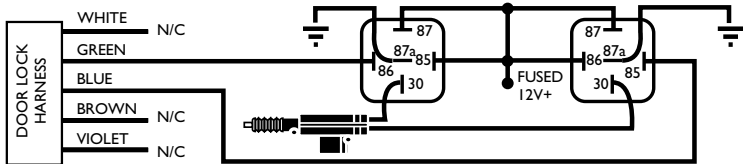

REVERSE POLARITY FACTORY DOOR LOCK SYSTEM

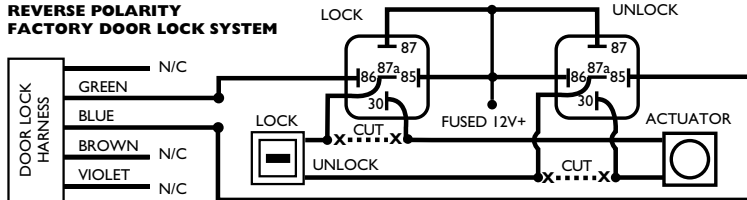

MERCEDES (VACUUM SYSTEM) FOR MODELS WITHOUT DOOR LOCK RELAYS

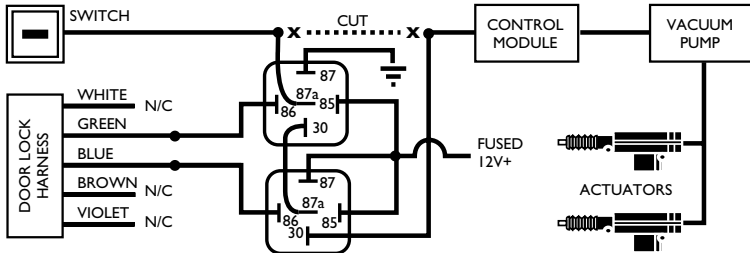

3 CHANNEL WITH ON BOARD DOOR LOCK RELAYS (3000, 3100, 3200)

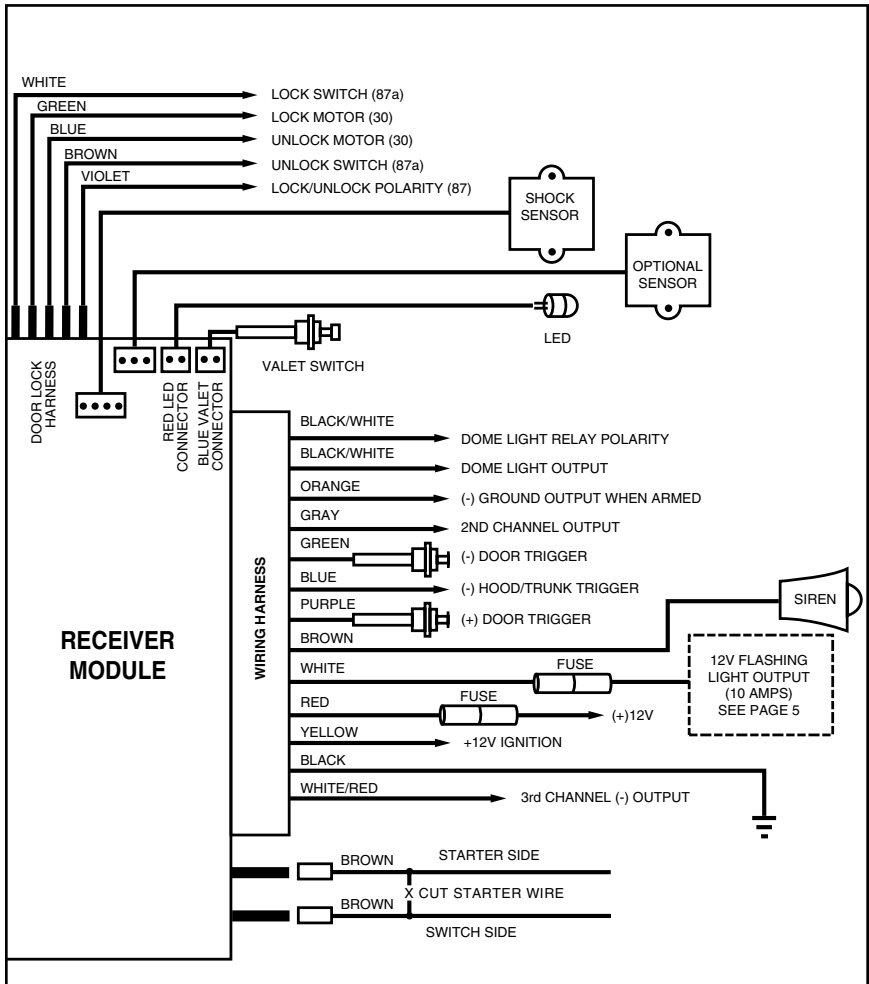

3 CHANNEL WITH ON BOARD DOOR LOCK RELAYS DOOR LOCK DIAGRAMS (3000, 3100, 3200)

POSITIVE PULSE DOOR LOCK SYSTEM

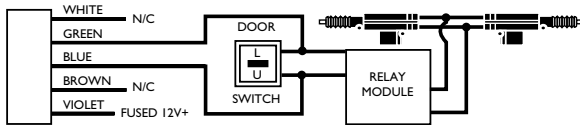

NEGATIVE PULSE DOOR LOCK SYSTEM

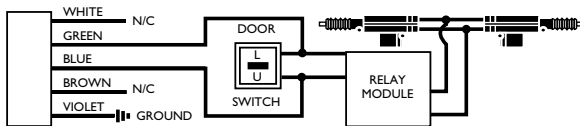

REVERSE POLARITY FACTORY DOOR LOCK SYSTEM

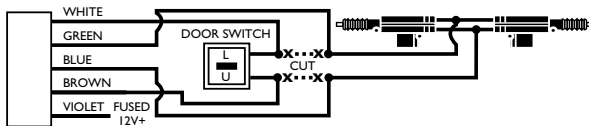

ADDING ACTUATORS

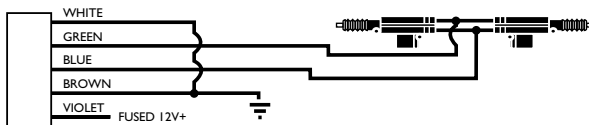

MERCEDES (VACUUM SYSTEM) DIP SWITCH TO #1 TO OFF

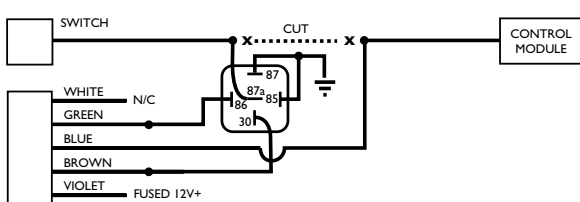

SYMPTOM	PROBABLE CAUSE	SUGGESTED CORRECTION
Alarm doesn't Arm/Disarm	Alarm in Valet Mode, ignition input has voltage on it, make sure the power and ground wires show 12V+	Take alarm out of Valet mode- turn key off - wrong wire connected to yellow wire main harness
Alarm will not Passively Arm	Dip Switch #4 is OFF, wrong polarity door input wire, Yellow ignition input has 12V+ on it.	Correct Dip Switch #4, Correct door switch polarity, change ignition input wire, make sure alarm is not in Valet.
Alarm will not go into Code Learning Mode	Not leaving ignition in the on position after turning it on & off three times. Not turning ignition on/off rapidly enough (5 sec.)	Repeat procedure quicker.
Alarm will not go into Code Learning Mode	Valet/Override Switch is defective or not plugged in.	Replace valet switch or Plug it in again.
Alarm chirps 4 times 30 seconds after system is Armed	Factory Dome light Delay is longer than 30 seconds. Door open or defective pin switch, Shock sensor is defective	If dome light delay is longer than 30 seconds no correction necessary. Replace defective pin switch or shock sensor.
Parking lights do not flash	Wrong wire connected to the White wire, or requires a negative output	Correct the wire connected to the White wire, Using a SPDT relay reverse polarity on white wire (see diagrams)
System Arms and Disarms but doesn't chirp siren	Chirp Delete mode is engaged	Turn ignition on, press and hold Button #2 until you hear 2 double chirps

SYMPTOM	PROBABLE CAUSE	SUGGESTED CORRECTION
Illuminated Entry doesn't come on upon disarm	Wrong polarity selected	Change polarity of the one Black/ White wire
Range is poor	Antenna wire is grounded, module is picking up interference from vehicles electrical system	Make sure antenna is not connected to anything, relocate module away from vehicle computer modules.
Vehicle starts when armed	Wrong starter wire was cut	Locate proper starter wire and reconnect
Car will not start when system is disarmed	Bad connection on brown starter wire harness.	Repair connection at starter wire, replace module.
Door locks do not work with remote	Wrong door lock polarity, Wrong lock wires connected	See door lock diagram, verify vehicle lock/unlock wires
Ignition triggered door lock feature doesn't operate	Yellow wire still has voltage on it, door input is showing open door	Connect yellow wire to the proper ignition wire, door input wire is connected to wrong wire or reverse polarity
Car horn honks when system disarmed and door is opened	Vehicle factory security system needs to be disarmed	Locate disarm wire (drivers kick panel?) use neg. unlock pulse to disarm factory system.
Alarm system intermittently works	Bad power and ground connections	Replace and secure power and ground connections
Car won't start; Alarm won't function properly	Vehicle battery dead or drops below 7.5 volts when trying to start the vehicle	Replace battery or charge.

**FOR NEGATIVE
PARKING LIGHTS
(MOST
JAPANESE
VEHICLES)**

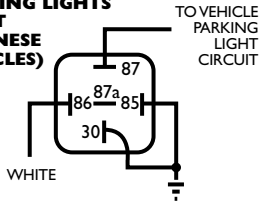

**FOR POSITIVE
PARKING LIGHTS**

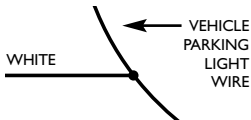

**TRUNK RELEASE
CIRCUIT DIAGRAM:**

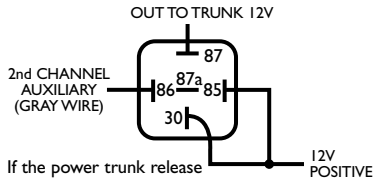

If the power trunk release requires a positive pulse to operate, use this circuit.

OPTIONAL DISABLER CIRCUIT

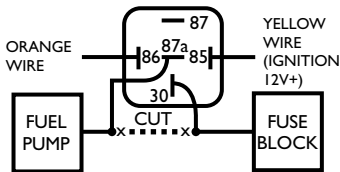

STATUS INDICATOR (LED) FUNCTIONS

- Off= System off in Active Mode
- Slow Flash= System Armed
- Rapid Flash= Passive Pre Arm State
- Rapid Flash (after disarm)= System was triggered
- On Solid= In Valet
- On Solid= (After passive prearm or active arm)
- 10 second final prearm state
- On Solid= (when disarmed, and not in Valet)
- Input is open. See Test Mode.

SILENT TEST MODE

When the system is disarmed the LED will go solid every time an input is triggered. You can check the shock sensor, doors, hood, trunk, and the auxiliary sensor input as well.

SIREN CHIRP STATUS

- 1 chirp= system armed
- 2 chirps= system disarmed
- 3 chirps= System disarmed, but alarm was triggered while away.
- 4 chirps= Alarm armed but there is a trigger that remains open. (This occurs 25 seconds after system was armed)
- 5 rapid chirps= Alarm armed, shock sensor warn away output was triggered.